







**BETTER COLOUR AND VALUE.
 BIGGER POSSIBILITIES.**

The Epson SureColor™ SC-S30670 is designed to deliver exceptional quality at a low total cost of ownership. Its advanced Micro Piezo Thin Film Piezo® print head, eco-friendly UltraChrome GS2 inks and large format output open up new possibilities for all types of indoor and outdoor commercial printing applications including posters, signs, banners, backlit panels, interior decorations, exhibition panels and more.

- 
 1-Year
 Warranty
- 
 Up to
 162.6cm
 (64") Wide
- 
 Epson
 Genuine Inks
- 
 Environment
 Friendly



EPSON ULTRACHROME
GS2^{INK}

4 COLOURS 4 INKS MAX. 	GS2 ULTRACHROME GS2 INK	MAXIMUM MEDIA WIDTH	MAX. INK CAPACITY PER COLOUR	MICRO PIEZO TFP PRINT HEAD	PRINT SPEEDS	SQM/HR
		162.6cm (64")	700ML	SINGLE	HIGH QUALITY PRODUCTION	7.3 14.7

ENGINEERED FOR BUSINESS

Low Total Cost of Ownership

Print at a lower cost per page on a variety of media up to 162.6cm (64") wide with a comprehensive 1-year warranty.

Renowned Epson Colour Printing Quality

Proven Micro Piezo TFP® print head and new UltraChrome GS2 inks deliver exceptional colour and details.

Uncompromised Productivity

Prints at 29.4m²/h in high-speed mode, 9.4 – 14.7m²/h in production mode without a dedicated RIP.

Enjoy low total cost of ownership while reaping the benefits of Epson's renowned colour quality to quickly produce outstanding printouts up to 162.6cm (64-inch) wide for a suite of indoor and outdoor commercial applications.



Low Total Cost of Ownership

Designed to give a low total cost of ownership, the SC-S30670 deftly produces everything from posters, signs, banners, backlit panels and POS to interior decorations and exhibition displays. Users can reliably and cost-effectively print on coated or uncoated solvent media, including adhesive-based vinyl, canvas, clear film, photographic paper and a range of popular

media, up to 162.6cm (64") in size. To top it off, users enjoy greater peace of mind with a comprehensive 1-year warranty that covers all parts including the print head for SC-S30670, plus a Starter Kit consisting of 700ml cartridges for cyan, magenta, yellow and black inks.

Renowned Epson Colour Printing Quality

Innovative Epson technologies in the SC-S30670 bring unrivalled colour and print quality to put you ahead of the competition.

New UltraChrome GS2 Ink

Building on the strength of Epson UltraChrome GS ink, the new ink set features a yellow formulation with light-fastness for up to three years*, tripling the previous level of durability. The eco-friendly eco-solvent ink set is odourless, nickel-free and has significantly reduced harmful volatile organic compounds (VOC), making it safe for use in both offices and outdoor environments.

*UltraChrome GS2/GSX inks meet the chemical requirements of the Nordic Ecolabel (Nordic Swan) for printing companies. Measured using Epson testing standards, using selected media from 3M and Avery Dennison Corporation. Please check details at the local Epson office.



Micro Piezo Thin Film Piezo® Print Head

Epson's proven and robust Micro Piezo TFP™ print head achieves extreme precision in ink droplet placement while doubling on the standard nozzle count from 180 to 360 per colour.

Half Tone Module (HTM)

To ensure flawless reproduction of skin tones and subtle colour gradations, Epson has created a Half Tone Module (HTM) for its advanced Look-Up Table (LUT) technology. HTM is also available when printing directly through our Adobe Illustrator plug-in.

Advanced Look-Up Table (LUT) Technology

Intelligent conversion of RGB to CMYK colour information is accomplished through Epson's advanced LUT technology, which leverages the wide colour gamut of the inks in an ideal blend that is ideal for the type of image being printed. The result is greater colour accuracy and consistency every time.



Uncompromised Productivity

Thanks to its Epson-engineered performance, reliability and ergonomic handling, the SC-S30670 deftly handles high and continuous workloads.

Faster Throughput



The SC-S30670 is the fastest* in its class, achieving 29.4m²/h in High Speed Mode and 9.4 – 14.7m²/h in Production Mode.

*Speed depends on each RIP. Above are supported by the Epson Illustrator Plug in Software.

Easy Roll Media Loading

Thanks to a jack at the rear, loading a new roll is a one-person job. Media tensioning can be controlled easily from front or back of the printer for speedier set-up to maximise productivity. 'Auto Tension Control' and three platen gap settings ensure accurate and efficient media feeding for reliable and continuous printing.

Adobe Illustrator Plug-in

Epson's plug-in software for Adobe Illustrator* allows direct printing to the SC-S30670 without the need of a Raster Image Processor (RIP). The plug-in provides an easy-to-use interface for easy print settings and one-touch printing.

*Supports Adobe Illustrator version CS5 or later. Free to download from Epson website.

Back-up Function for Custom Media Settings

Custom media settings for common or special jobs can be stored on LFP Remote Panel 2 on a user's workstation and shared with other connected SureColor printers.

On-the-fly Paper Feed Adjustment

A short-cut button on the control panel lets users correct the paper feed even while printing is in progress, thereby reducing print wastage.

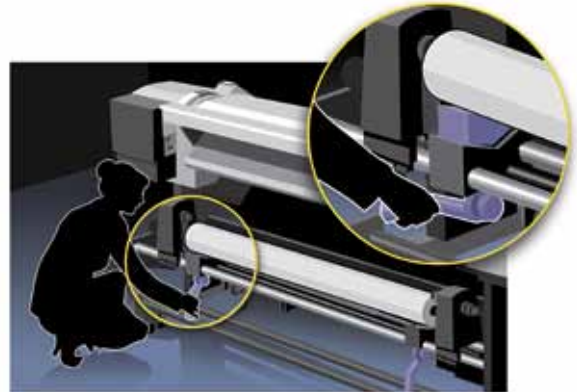

Designed for Ease-of-Use

Thoughtful hardware and software design makes the SC-S30670 a breeze to operate and maintain.

User-Friendly Layout

All major operations and settings can be accessed conveniently on the right side of the printer.

Easy-to-Use Interface

Short cut buttons allow easy access to frequently used functions, including direct access for Maintenance, Heating and Drying.

Large 6.25cm (2.46") Colour LCD Screen

Check printer settings at a glance on the large and clear 6.25cm (2.46") colour LCD screen.



Alert Lamp & Buzzer

In the event of printer error, users are quickly alerted.

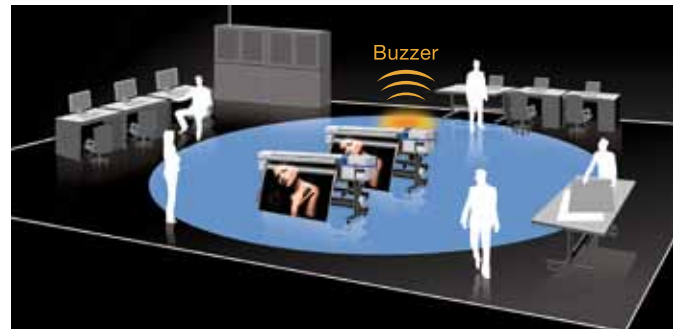

Status Notification System

Status alerts for instances such as 'End of Print Job', 'Error' or 'Ink Running Out' can be sent to users via e-mail notification, receivable through networked PCs or smartphones.



MODEL NUMBER	SC-S30670
Printing Technology	
Print Head	Micro Piezo TFP®
Maximum Resolution	1440 X 1440 dpi
Ink System	
Ink Type	Epson Ultrachrome® GS2
Colours	Cyan, Magenta, Yellow, Black
Ink Capacity	700ml
Print Speed	
High Speed, 720 X 720, 2-pass	29.4m ² /h
Production 1, 720 X 720, 4-pass	14.7/h
Production 2, 720 X 1440, 6-pass	9.9m ² /h
High Quality, 720 X 1440, 8-pass	7.3 m ² /h
Paper Handling	
Roll Media Dimension	
Outer Diametre	Up to 250mm
Width	30 – 1625.6mm (64")
Print Area	
Width	300 – 1615.6mm
Margin	5mm each side
Control Panel	2.46" TFT Colour LCD
Connectivity	
Standard	USB 2.0 Hi-Speed
Ethernet	100Base-TX/1000Base-T
Memory	
Main	512MB
Network	128MB
Software	Communication Driver, Online Guide, LFP RemotePanel 2, EpsonNet Config
Electrical Specifications	
Rated Voltage	AC 100-240V (Rated voltage will vary depending on area)
Rated Frequency	50-60 Hz
Power Consumption	
Operating	Approx. 650W
Standby	Approx. 520W (heater ON), 30W (heater OFF)
Sleep	Approx. 10W
Power Off	Less than 0.6W
Weight	219kg
Options	Order Code
Additional Print Drying System	C12C890751
Heavy Roll Media System	C12C890761
Media Holding Plate	C12C890891
Waste Ink Bottle	C12T724000
Maintenance Kit	C12T724100
Ink Cleaner	C12T699300
Warranty	Standard 1-year onsite, inclusive of parts and print head

Supplied accessories

Document Pack (Installation CD and Paper Manual)
 Substrate Support System
 Starter Kit - 700ml CMYK inks
 350ml Cleaning Cartridge

Dimensions

Weight: 219kg

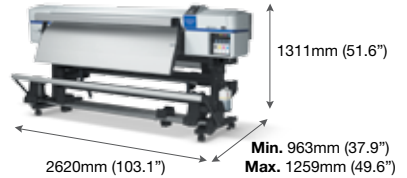

Ink Cartridge Compatibility

700ml Ink Cartridges

- Black C13T689100
- Cyan C13T689200
- Magenta C13T689300
- Yellow C13T689400
- 350ml Cleaning Cartridge C13T699000

For the best results, always use genuine Epson ink.



Reproduction in part or in whole, without the written permission from Epson, is strictly prohibited. EPSON and EXCEED YOUR VISION are registered trademarks of Seiko Epson Corporation. All other products names and other company names used herein are for identification purposes only and are the trademarks or registered trademarks of their respective owners. Epson disclaims any and all rights in those marks. Print samples shown are simulations only. Specifications and product availability are subject to change without notice and may vary between countries. Please check with local Epson offices for more information.

EPSON INDIA PVT. LTD.

12th Floor, The Millenia, Tower A, No.1, Murphy Road, Ulsoor, Bangalore - 560 008.
 Tel: 080-30515000 Fax: 080-30515005

Regional Offices:

Ahmedabad - 26407176/77, Chennai - 30277500/11, Cochin - 4012315, Coimbatore - 98942 19200,
 Indore - 4701830, Kolkata - 22831589/90, Mumbai - 28261515-17, New Delhi - 46585444,
 Pune - 30286000, Secunderabad - 40359898



For product info: North & East: Alok Singh 98108 67058 West: Rajimon
 Raghavan 77388 93141 South: Ganesh 96000 18541 / Vasu 98453 31744
For service: ifpsupport@eid.epson.co.in

www.epson.co.in

Dealer's Stamp



Official Partner
 of Manchester United